

mimatic®

Tool Systems

Your Partner For Clever Tooling

Rotierende und stehende Aufnahmen
Rotating and static tool holder

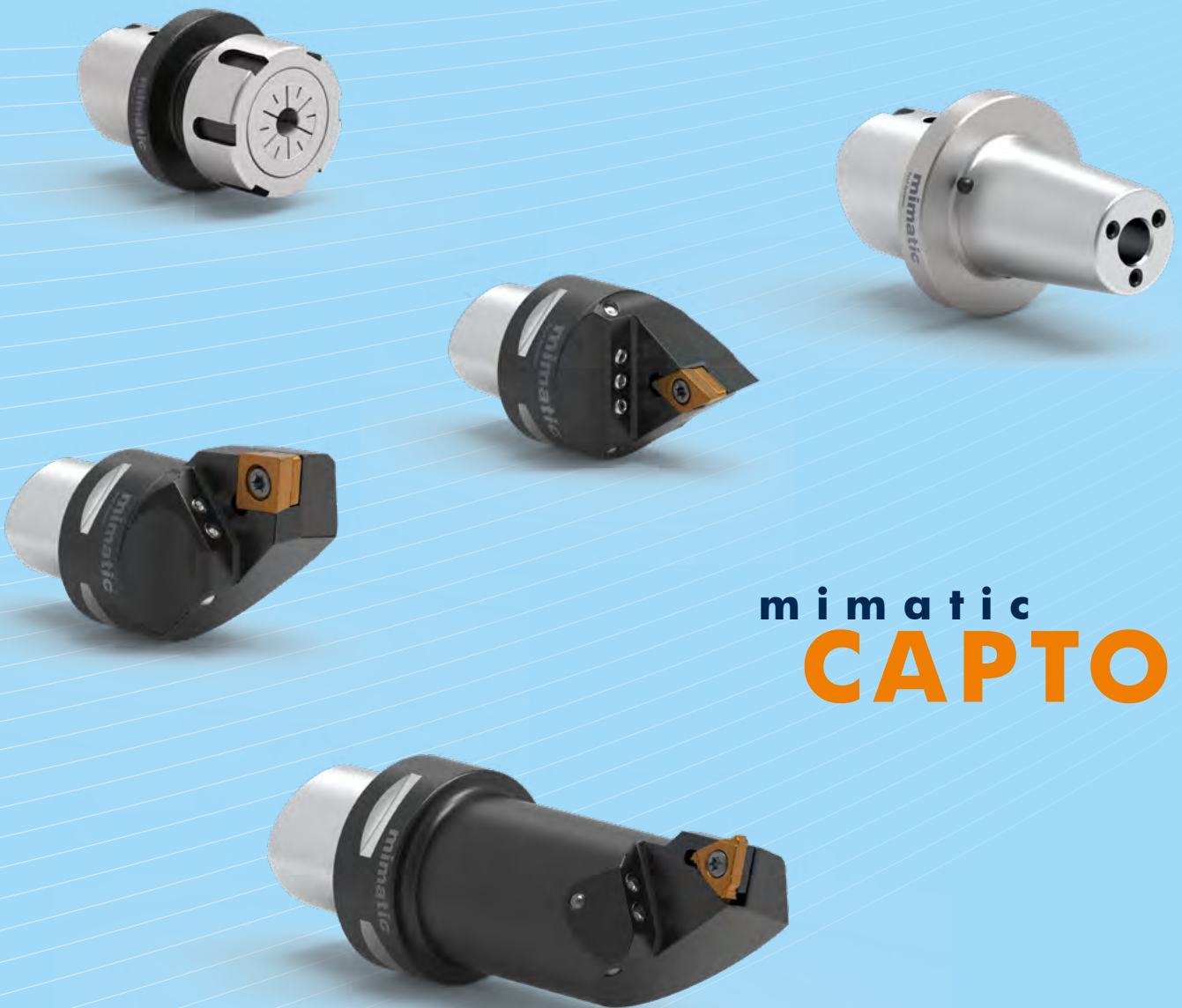

mimatic
CAPTO

Hersteller von Präzisions-Werkzeugen seit 1974
Manufacturer of Precision Tools Since 1974

Rotierende Aufnahmen mimatic CAPTO ISO 26623-1

Rotating tool holder mimatic CAPTO ISO 26623-1

ER Spannzangenfutter DIN 6499 - Ohne Greiferrille
ER Collet chucks DIN 6499 - No gripper groove

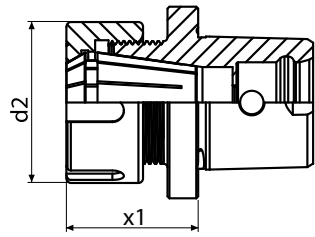

Interne Kühlmittelzufuhr
Internal coolant supply

Bestell Nr. Order No.	Größe Size	Aufnahme Toolholder	Bereich Range	x1	d2
199913	C4	ER20	1 - 13	32	35
199914	C4	ER25	1 - 16	35	42
199915	C4	ER32	2 - 20	52	50
199916	C5	ER25	1 - 16	34	42
199917	C5	ER32	2 - 20	41	50
199918	C5	ER40	3 - 26	58	63

Bestell Nr. Order No.	Größe Size	d1	x1	d2
199919	C4	6	30	19
199920	C4	8	30	21
199921	C4	10	34	28
199922	C4	12	39	34
199923	C4	14	39	36
199924	C4	16	43	38
199925	C4	18	43	40
199926	C4	20	45	45
199927	C5	6	29	19
199928	C5	8	29	21
199929	C5	10	33	28
199930	C5	12	38	34
199931	C5	14	38	36
199932	C5	16	41	38
199933	C5	18	42	40
199934	C5	20	44	45
199935	C5	25	50	51

Fräshalter DIN 1835-B - Ohne Greiferrille
End mill holders DIN 1835-B - No gripper groove

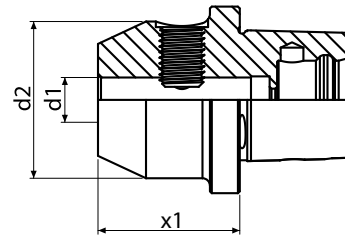

Interne Kühlmittelzufuhr
Internal coolant supply

"3 in 1" THERMO-Schrumpffutter - Ohne Greiferrille
"3 in 1" THERMO Shrink-fit chucks - No gripper groove

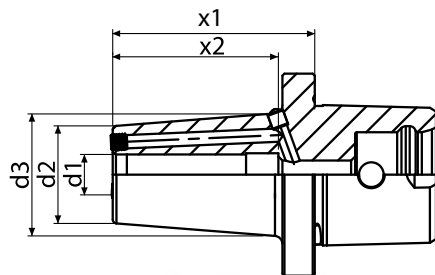

Interne Kühlmittelzufuhr
Internal coolant supply

Bestell Nr. Order No.	Größe Size	d1	x1	d2	d3	x2
199936	C4	6	49	20	24,5	36
199937	C4	8	49	20	24,5	36
199938	C4	10	49	24	28,5	41
199939	C4	12	49	24	28,5	46
199940	C4	14	49	27	31,5	46
199941	C4	16	54	27	32,3	49
199943	C5	6	50	20	24,5	36
199944	C5	8	50	20	24,5	36
199945	C5	10	50	24	28,5	41
199946	C5	12	50	24	28,5	46
199947	C5	14	50	27	31,5	46
199949	C5	16	55	27	32,3	49

Kombi-Aufsteckfräsdorn - Ohne Greiferrille
Combination Shell End Mill Arbor - No gripper groove

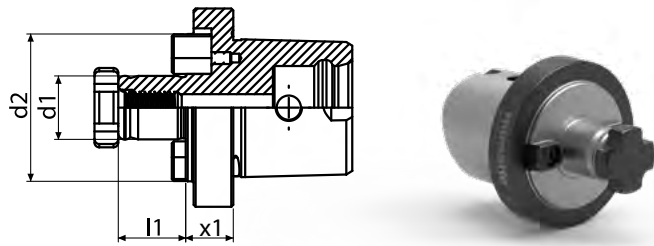

Bestell Nr. Order No.	Größe Size	d1	x1	d2	l1
199952	C4	16	10	40	17
199953	C4	22	12	45	19
199954	C5	16	10	50	17
199956	C5	22	12	50	19
199957	C5	27	12	50	21
199958	C5	32	18	63	24

Stehende Aufnahmen mimatic CAPTO ISO 26623-1
Static tool holder mimatic CAPTO ISO 26623-1

Drehwerkzeughalter - extern
Turning tool holders - external



Abbildung zeigt rechte Ausführung
Figure shows right version

Klemmkeil
Wedge clamp

Direkte Kühlmittelzufuhr
Direct coolant supply

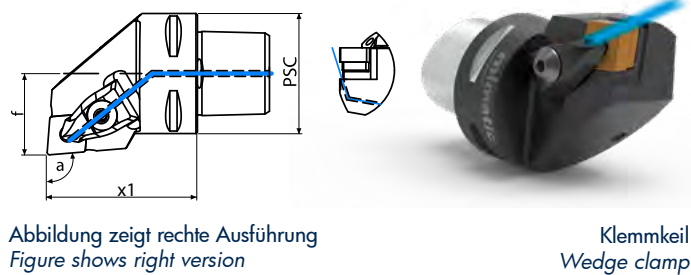

Bestell Nr. Order No.	Größe Size	Ausrichtung Orientation	Einsatz Insert	a	x1	f
199884	C4	Rechts/Right	CNM..1204..	95°	50	27
199885	C4	Links/Left	CNM..1204..	95°	50	27
199886	C5	Rechts/Right	CNM..1204..	95°	60	35
199887	C5	Links/Left	CNM..1204..	95°	60	35
200736	C6	Rechts/Right	CNM..1204..	95°	65	45
200737	C6	Links/Left	CNM..1204..	95°	65	45

Ersatzteile Spare Parts						
Bestell Nr. Order No.	Right 199960 Left 199961	199966	199968	199975	107578	199977

Drehwerkzeughalter - extern
Turning tool holders - external



Abbildung zeigt rechte Ausführung
Figure shows right version

Klemmkeil
Wedge clamp

Externe Kühlmittelzufuhr
External coolant supply

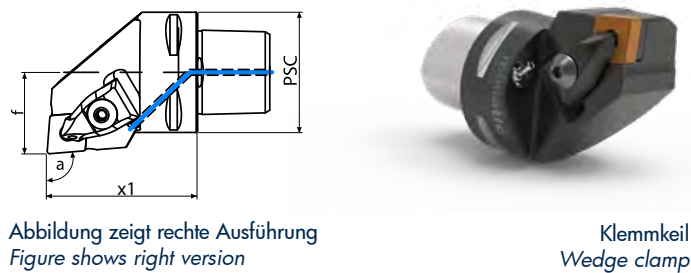

Bestell Nr. Order No.	Größe Size	Ausrichtung Orientation	Einsatz Insert	a	x1	f
199888	C4	Rechts/Right	CNM..1204..	95°	50	27
199889	C4	Links/Left	CNM..1204..	95°	50	27
199890	C5	Rechts/Right	CNM..1204..	95°	60	35
199892	C5	Links/Left	CNM..1204..	95°	60	35
200738	C6	Rechts/Right	CNM..1204..	95°	65	45
200739	C6	Links/Left	CNM..1204..	95°	65	45

Ersatzteile Spare Parts							
Bestell Nr. Order No.	199962	199967	199968	199975	107578	199978	199981

Stehende Aufnahmen mimatic CAPTO Static tool holder mimatic CAPTO

Drehwerkzeughalter - extern
Turning tool holders - external



Abbildung zeigt rechte Ausführung
Figure shows right version



Klemmkeil
Wedge clamp

Direkte Kühlmittelzufuhr
Direct coolant supply

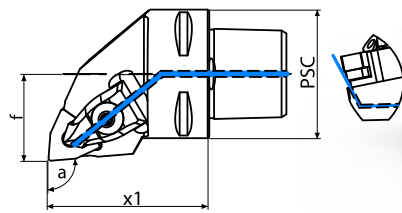

Bestell Nr. Order No.	Größe Size	Ausrichtung Orientation	Einsatz Insert	a	x1	f
199893	C4	Rechts/Right	WNM..0804..	95°	50	27
199894	C4	Links/Left	WNM..0804..	95°	50	27
199895	C5	Rechts/Right	WNM..0804..	95°	60	35
199896	C5	Links/Left	WNM..0804..	95°	60	35
200740	C6	Rechts/Right	WNM..0804..	95°	65	45
200741	C6	Links/Left	WNM..0804..	95°	65	45

Ersatzteile Spare Parts						
Bestell Nr. Order No.	Right 199960 Left 199961	199966	199969	199975	107578	199977

Drehwerkzeughalter - extern
Turning tool holders - external



Abbildung zeigt rechte Ausführung
Figure shows right version



Klemmkeil
Wedge clamp

Externe Kühlmittelzufuhr
External coolant supply

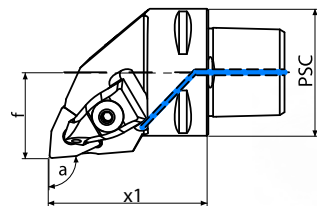

Bestell Nr. Order No.	Größe Size	Ausrichtung Orientation	Einsatz Insert	a	x1	f
199897	C4	Rechts/Right	WNM..0804..	95°	50	27
199898	C4	Links/Left	WNM..0804..	95°	50	27
199899	C5	Rechts/Right	WNM..0804..	95°	60	35
199900	C5	Links/Left	WNM..0804..	95°	60	35
200742	C6	Rechts/Right	WNM..0804..	95°	65	45
200743	C6	Links/Left	WNM..0804..	95°	65	45

Ersatzteile Spare Parts							
Bestell Nr. Order No.	199962	199967	199969	199975	107578	199978	199981

Drehwerkzeughalter - extern
Turning tool holders - external



Abbildung zeigt rechte Ausführung
Figure shows right version



Klemmkeil
Wedge clamp

Direkte Kühlmittelzufuhr
Direct coolant supply

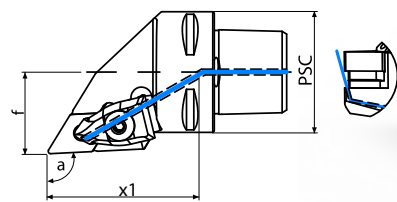

Bestell Nr. Order No.	Größe Size	Ausrichtung Orientation	Einsatz Insert	a	x1	f
199901	C4	Rechts/Right	DNM..1506..	93°	55	27
199902	C4	Links/Left	DNM..1506..	93°	55	27
199903	C5	Rechts/Right	DNM..1506..	93°	60	35
199904	C5	Links/Left	DNM..1506..	93°	60	35
200744	C6	Rechts/Right	DNM..1506..	93°	65	45
200745	C6	Links/Left	DNM..1506..	93°	65	45

Ersatzteile Spare Parts						
Bestell Nr. Order No.	Right 199960 Left 199961	199966	199970	199975	107578	199977

Stehende Aufnahmen mimatic CAPTO

Static tool holder mimatic CAPTO

Drehwerkzeughalter - extern
Turning tool holders - external



Abbildung zeigt rechte Ausführung
Figure shows right version



Klemmkeil
Wedge clamp

Externe Kühlmittelzufuhr
External coolant supply

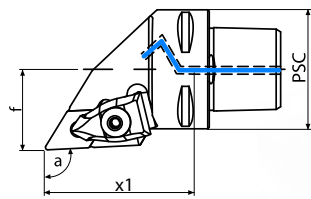

Bestell Nr. Order No.	Größe Size	Ausrichtung Orientation	Einsatz Insert	a	x1	f
199905	C4	Rechts/Right	DNM..1506..	93°	55	27
199906	C4	Links/Left	DNM..1506..	93°	55	27
199907	C5	Rechts/Right	DNM..1506..	93°	60	35
199908	C5	Links/Left	DNM..1506..	93°	60	35
200746	C6	Rechts/Right	DNM..1506..	93°	65	45
200747	C6	Links/Left	DNM..1506..	93°	65	45

Ersatzteile Spare Parts							
Bestell Nr. Order No.	199962	199967	199970	199975	107578	199978	199981

Drehwerkzeughalter - extern
Turning tool holders - external

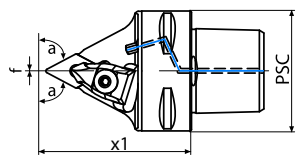

Klemmkeil
Wedge clamp

Externe Kühlmittelzufuhr
External coolant supply



Bestell Nr. Order No.	Größe Size	Ausrichtung Orientation	Einsatz Insert	a	x1	f
199909	C4	Neutral	DNM..1506..	62,5°	55	0,5
199910	C5	Neutral	DNM..1506..	62,5°	60	0,5
200748	C6	Neutral	DNM..1506..	62,5°	65	0,5

Ersatzteile Spare Parts							
Bestell Nr. Order No.	199962	199967	199970	199975	107578	199978	199981

Drehwerkzeughalter - extern
Turning tool holders - external

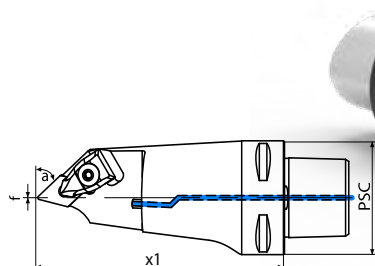

Klemmkeil
Wedge clamp

Externe Kühlmittelzufuhr
External coolant supply



Bestell Nr. Order No.	Größe Size	Ausrichtung Orientation	Einsatz Insert	a	x1	f
199911	C5	Left	DNM..1506..	48°	115	1
200749	C6	Left	DNM..1506..	48°	120	1

Ersatzteile Spare Parts							
Bestell Nr. Order No.	199962	199967	199970	199975	107578	199978	199981

Stehende Aufnahmen mimatic CAPTO Static tool holder mimatic CAPTO

Drehwerkzeughalter - extern
Turning tool holders - external



Abbildung zeigt rechte Ausführung
Figure shows right version



Klemmkeil
Wedge clamp

Externe Kühlmittelzufuhr
External coolant supply

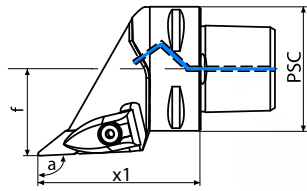

Bestell Nr. Order No.	Größe Size	Ausrichtung Orientation	Einsatz Insert	a	x1	f
199853	C4	Rechts/Right	VNM..1604..	93°	62	27
199854	C4	Links/Left	VNM..1604..	93°	62	27
199855	C5	Rechts/Right	VNM..1604..	93°	65	35
199856	C5	Links/Left	VNM..1604..	93°	65	35
200750	C6	Rechts/Right	VNM..1604..	93°	65	45
200751	C6	Links/Left	VNM..1604..	93°	65	45

Ersatzteile Spare Parts							
Bestell Nr. Order No.	Spannkralle Clamp 199963	Spannschraube Clamp screw 199967	Unterlegplatte Shim 199971	Stellschraube Shim screw 199976	Sechskantschl. Key 107578	Spritzdüse Nozzle 199978	Feder Spring 199981

Drehwerkzeughalter - extern
Turning tool holders - external

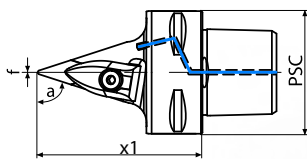

Klemmkeil
Wedge clamp

Externe Kühlmittelzufuhr
External coolant supply



Bestell Nr. Order No.	Größe Size	Ausrichtung Orientation	Einsatz Insert	a	x1	f
199857	C4	Neutral	VNM..1604..	72,5°	62	0
199858	C5	Neutral	VNM..1604..	72,5°	65	0
200752	C6	Neutral	VNM..1604..	72,5°	65	0

Ersatzteile Spare Parts							
Bestell Nr. Order No.	Spannkralle Clamp 199963	Spannschraube Clamp screw 199967	Unterlegplatte Shim 199971	Stellschraube Shim screw 199976	Sechskantschl. Key 107578	Spritzdüse Nozzle 199978	Feder Spring 199981

Drehwerkzeughalter - extern
Turning tool holders - external



Abbildung zeigt rechte Ausführung
Figure shows right version



Kniehebelspannung
Lever-look clamp

Externe Kühlmittelzufuhr
External coolant supply

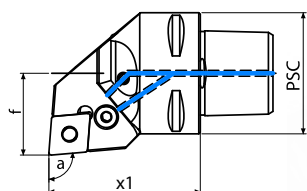

Bestell Nr. Order No.	Größe Size	Ausrichtung Orientation	Einsatz Insert	a	x1	f
199859	C4	Rechts/Right	CNM..1204..	95°	50	27
199860	C4	Links/Left	CNM..1204..	95°	50	27
199861	C5	Rechts/Right	CNM..1204..	95°	60	35
199862	C5	Links/Left	CNM..1204..	95°	60	35
200753	C6	Rechts/Right	CNM..1204..	95°	65	45
200754	C6	Links/Left	CNM..1204..	95°	65	45

Ersatzteile Spare Parts						
Bestell Nr. Order No.	Kniehebel Lever 199964	Kniehebelschraube Lever screw 199982	Unterlegplatte Shim 199968	Feder Shim pin 199980	Sechskantschlüssel Key 107578	Spritzdüse Nozzle 199979

Stehende Aufnahmen mimatic CAPTO

Static tool holder mimatic CAPTO

Drehwerkzeughalter - extern
Turning tool holders - external

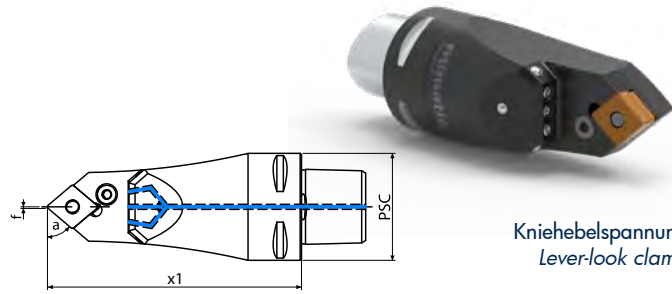

Kniehebelspannung
Lever-look clamp

Externe Kühlmittelzufuhr
External coolant supply



Bestell Nr. Order No.	Größe Size	Ausrichtung Orientation	Einsatz Insert	a	x1	f
199863	C4	Neutral	CNM..1204..	50°	95	0
199864	C5	Neutral	CNM..1204..	50°	115	0
200755	C6	Neutral	CNM..1204..	50°	115	0

Ersatzteile Spare Parts						
	Kniehebel Lever	Kniehebelschraube Lever screw	Unterlegplatte Shim	Feder Shim pin	Sechskantschlüssel Key	Spritzdüse Nozzle
Bestell Nr. Order No.	199964	199982	199968	199980	107578	199979

Drehwerkzeughalter - extern
Turning tool holders - external



Abbildung zeigt rechte Ausführung
Figure shows right version

Kniehebelspannung
Lever-look clamp

Externe Kühlmittelzufuhr
External coolant supply

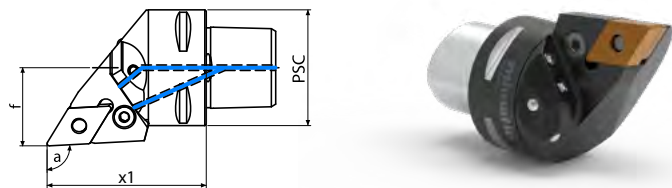

Bestell Nr. Order No.	Größe Size	Ausrichtung Orientation	Einsatz Insert	a	x1	f
199865	C4	Rechts/Right	DNM..1506..	93°	55	27
199866	C4	Links/Left	DNM..1506..	93°	55	27
199867	C5	Rechts/Right	DNM..1506..	93°	60	35
199868	C5	Links/Left	DNM..1506..	93°	60	35
200756	C6	Rechts/Right	DNM..1506..	93°	65	45
200757	C6	Links/Left	DNM..1506..	93°	65	45

Ersatzteile Spare Parts						
	Kniehebel Lever	Kniehebelschraube Lever screw	Unterlegplatte Shim	Feder Shim pin	Sechskantschlüssel Key	Spritzdüse Nozzle
Bestell Nr. Order No.	199964	199982	199970	199980	107578	199979

Drehwerkzeughalter - extern
Turning tool holders - external



Abbildung zeigt rechte Ausführung
Figure shows right version

Spannschraube
Screw clamp

Externe Kühlmittelzufuhr
External coolant supply

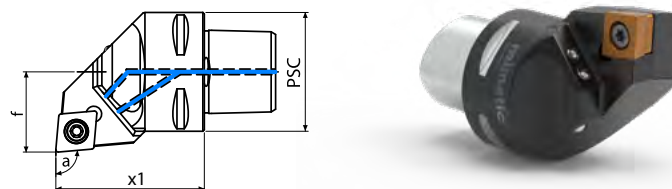

Bestell Nr. Order No.	Größe Size	Ausrichtung Orientation	Einsatz Insert	a	x1	f
199869	C4	Rechts/Right	CCM..1204..	95°	50	27
199870	C4	Links/Left	CCM..1204..	95°	50	27
199871	C5	Rechts/Right	CCM..1204..	95°	60	35
199872	C5	Links/Left	CCM..1204..	95°	60	35
200758	C6	Rechts/Right	CCM..1204..	95°	65	45
200759	C6	Links/Left	CCM..1204..	95°	65	45

Ersatzteile Spare Parts						
	Einsatzschraube Insert screw	Unterlegplatte Shim	Wendepfannschraube Shim screw	Torxschlüssel Torx Key	Sechskantschlüssel Key	Spritzdüse Nozzle
Bestell Nr. Order No.	199983	199972	199989	111684	199994	199979

Stehende Aufnahmen mimatic CAPTO Static tool holder mimatic CAPTO

Drehwerkzeughalter - extern
Turning tool holders - external



Abbildung zeigt rechte Ausführung
Figure shows right version



Spannschraube
Screw clamp

Externe Kühlmittelzufuhr
External coolant supply

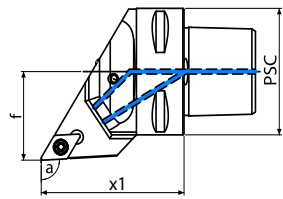

Bestell Nr. Order No.	Größe Size	Ausrichtung Orientation	Einsatz Insert	a	x1	f
199873	C4	Rechts/Right	DCM..11T3..	93°	50	27
199874	C4	Links/Left	DCM..11T3..	93°	50	27
199875	C5	Rechts/Right	DCM..11T3..	93°	60	35
199876	C5	Links/Left	DCM..11T3..	93°	60	35
200760	C6	Rechts/Right	DCM..11T3..	93°	65	45
200761	C6	Links/Left	DCM..11T3..	93°	65	45

Ersatzteile Spare Parts						
	Einsatzschraube Insert screw	Unterlegplatte Shim	Wendeplattenschraube Shim screw	Torxschlüssel Torx Key	Sechskantschlüssel Key	Spritzdüse Nozzle
Bestell Nr. Order No.	199984	199973	199987	111651	199993	199979

Drehwerkzeughalter - extern
Turning tool holders - external

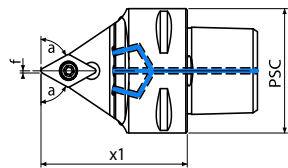

Spannschraube
Screw clamp

Externe Kühlmittelzufuhr
External coolant supply



Bestell Nr. Order No.	Größe Size	Ausrichtung Orientation	Einsatz Insert	a	x1	f
199877	C4	Neutral	DCM..11T3..	62,5°	50	0
199878	C5	Neutral	DCM..11T3..	62,5°	60	0

Ersatzteile Spare Parts						
	Einsatzschraube Insert screw	Unterlegplatte Shim	Wendeplattenschraube Shim screw	Torxschlüssel Torx Key	Sechskantschlüssel Key	Spritzdüse Nozzle
Bestell Nr. Order No.	199984	199973	199987	111651	199993	199979

Drehwerkzeughalter - extern
Turning tool holders - external



Abbildung zeigt rechte Ausführung
Figure shows right version



Spannschraube
Screw clamp

Externe Kühlmittelzufuhr
External coolant supply

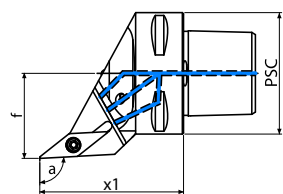

Bestell Nr. Order No.	Größe Size	Ausrichtung Orientation	Einsatz Insert	a	x1	f
199880	C4	Rechts/Right	VB(VC)..1604..	93°	50	27
199881	C4	Links/Left	VB(VC)..1604..	93°	50	27
199882	C5	Rechts/Right	VB(VC)..1604..	93°	60	35
199883	C5	Links/Left	VB(VC)..1604..	93°	60	35
200762	C6	Rechts/Right	VB(VC)..1604..	93°	65	45
200763	C6	Links/Left	VB(VC)..1604..	93°	65	45

Ersatzteile Spare Parts						
	Einsatzschraube Insert screw	Unterlegplatte Shim	Wendeplattenschraube Shim screw	Torxschlüssel Torx Key	Sechskantschlüssel Key	Spritzdüse Nozzle
Bestell Nr. Order No.	199985 (C4) 199984 (C5,C6)	199974	199990	111651	199993	199979

Stehende Aufnahmen mimatic CAPTO

Static tool holder mimatic CAPTO

Drehwerkzeughalter - extern
Turning tool holders - external



Abbildung zeigt rechte Ausführung
Figure shows right version



Spannschraube
Screw clamp

Externe Kühlmittelzufuhr
External coolant supply

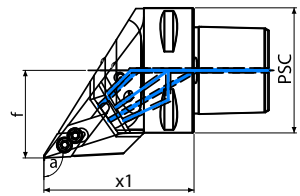

Bestell Nr. Order No.	Größe Size	Ausrichtung Orientation	Einsatz Insert	a	x1	f
200764	C4	Rechts/Right	VB(VC)..1604..	107,5°	50	27
200765	C4	Links/Left	VB(VC)..1604..	107,5°	50	27
200766	C5	Rechts/Right	VB(VC)..1604..	107,5°	60	35
200767	C5	Links/Left	VB(VC)..1604..	107,5°	60	35
200768	C6	Rechts/Right	VB(VC)..1604..	107,5°	65	45
200769	C6	Links/Left	VB(VC)..1604..	107,5°	65	45

Ersatzteile Spare Parts						
	Einsatzschraube Insert screw	Unterlegplatte Shim	Wendeplattenschraube Shim screw	Torxschlüssel Torx Key	Sechskantschlüssel Key	Spritzdüse Nozzle
Bestell Nr. Order No.	199984	199974	199991	111651	199993	199979

Drehwerkzeughalter - extern
Turning tool holders - external



Abbildung zeigt rechte Ausführung
Figure shows right version



Spannschraube
Screw clamp

Externe Kühlmittelzufuhr
External coolant supply

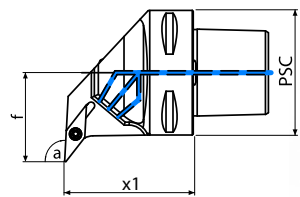

Bestell Nr. Order No.	Größe Size	Ausrichtung Orientation	Einsatz Insert	a	x1	f
200770	C6	Rechts/Right	VB(VC)..1604..	93°	63	45
200771	C6	Links/Left	VB(VC)..1604..	93°	63	45

Ersatzteile Spare Parts						
	Einsatzschraube Insert screw	Unterlegplatte Shim	Wendeplattenschraube Shim screw	Torxschlüssel Torx Key	Sechskantschlüssel Key	Spritzdüse Nozzle
Bestell Nr. Order No.	199984	199974	199991	111651	199993	199979

Drehwerkzeughalter - extern
Turning tool holders - external

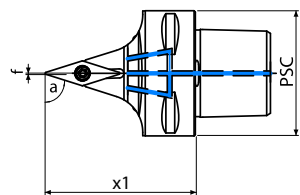

Spannschraube
Screw clamp

Externe Kühlmittelzufuhr
External coolant supply



Bestell Nr. Order No.	Größe Size	Ausrichtung Orientation	Einsatz Insert	a	x1	f
200772	C4	Neutral	VB(VC)..1604..	72,5°	55	0
200773	C5	Neutral	VB(VC)..1606..	72,5°	60	0
200774	C6	Neutral	VB(VC)..1608..	72,5°	65	0

Ersatzteile Spare Parts						
	Einsatzschraube Insert screw	Unterlegplatte Shim	Wendeplattenschraube Shim screw	Torxschlüssel Torx Key	Sechskantschlüssel Key	Spritzdüse Nozzle
Bestell Nr. Order No.	199984	199974	199991	111651	199993	199979

Stehende Aufnahmen mimatic CAPTO

Static tool holder mimatic CAPTO

Drehwerkzeughalter - extern
Turning tool holders - external

Externe Kühlmittelzufuhr
External coolant supply

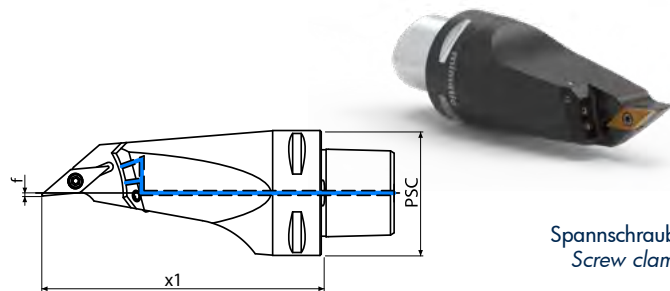

Spannschraube
Screw clamp

Bestell Nr. Order No.	Größe Size	Ausrichtung Orientation	Einsatz Insert	a	x1	f
201464	C5	Links/Left	VB(VC)..1604..	95°	115	1,2
201465	C6	Links/Left	VB(VC)..1604..	95°	130	1,2
201466	C6	Links/Left	VB(VC)..1604..	95°	120	33

Ersatzteile Spare Parts						
	Einsatzschraube Insert screw	Unterlegplatte Shim	Wendeplattenschraube Shim screw	Torxschlüssel Torx Key	Sechskantschlüssel Key	Spritzdüse Nozzle
Bestell Nr. Order No.	199984	199974	199991	111651	199993	199979

Drehwerkzeughalter - intern
Turning tool holders - internal

Externe Kühlmittelzufuhr
External coolant supply

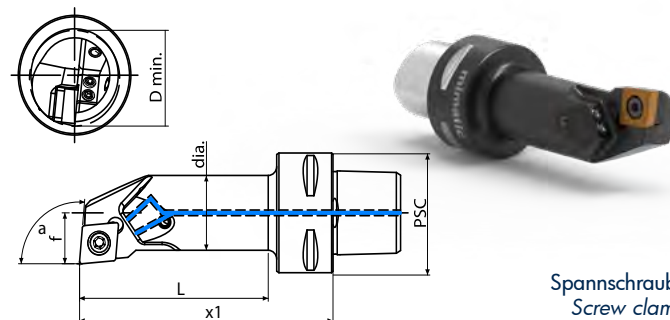

Spannschraube
Screw clamp

Bestell Nr. Order No.	Größe Size	Ausrichtung Orientation	Einsatz Insert	a	x1	f	dia.	D min	L
200775	C4	Rechts/Right	CCM..1204..	95°	50	17	25	32	69
200776	C4	Links/Left	CCM..1204..	95°	50	17	25	32	69
200777	C5	Rechts/Right	CCM..1204..	95°	90	17	25	32	67
200778	C5	Links/Left	CCM..1204..	95°	90	17	25	32	67

Abbildung zeigt rechte Ausführung
Figure shows right version

Ersatzteile Spare Parts						
	Einsatzschraube Insert screw	Unterlegplatte Shim	Wendeplattenschraube Shim screw	Torxschlüssel Torx Key	Sechskantschlüssel Key	Spritzdüse Nozzle
Bestell Nr. Order No.	199986	199972	199992	111684	199994	199979

Drehwerkzeughalter - intern
Turning tool holders - internal

Externe Kühlmittelzufuhr
External coolant supply

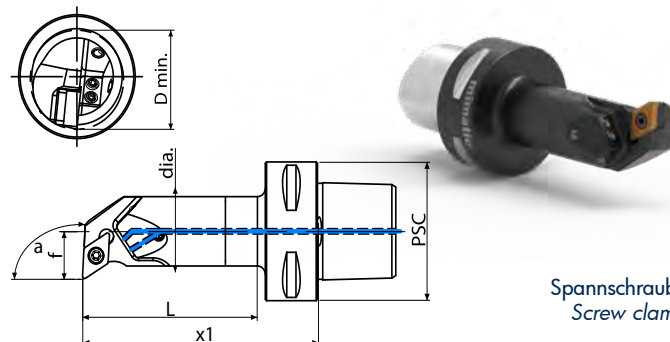

Spannschraube
Screw clamp

Bestell Nr. Order No.	Größe Size	Ausrichtung Orientation	Einsatz Insert	a	x1	f	dia.	D min	L
200779	C4	Rechts/Right	DCM..11T3..	93°	80	13	20	25	58
200780	C4	Links/Left	DCM..11T3..	93°	80	13	20	25	58
200781	C5	Rechts/Right	DCM..11T3..	93°	90	17	25	32	67
200782	C5	Links/Left	DCM..11T3..	93°	90	17	25	32	67

Abbildung zeigt rechte Ausführung
Figure shows right version

Ersatzteile Spare Parts						
	Einsatzschraube Insert screw	Unterlegplatte Shim	Wendeplattenschraube Shim screw	Torxschlüssel Torx Key	Sechskantschlüssel Key	Spritzdüse Nozzle
Bestell Nr. Order No.	199987	199973	199990	111651	199993	199979

Stehende Aufnahmen mimatic CAPTO

Static tool holder mimatic CAPTO

Drehwerkzeughalter - Aussengewinde
Turning tool holders - external thread



Abbildung zeigt rechte Ausführung
Figure shows right version



Spannschraube
Screw clamp

Externe Kühlmittelzufuhr
External coolant supply

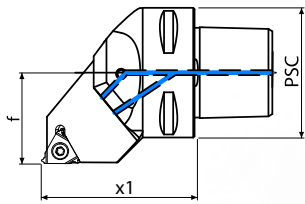

Bestell Nr. Order No.	Größe Size	Ausrichtung Orientation	Einsatz Insert	x1	f
200783	C4	Rechts/Right	16ER/L	50	27
200784	C4	Links/Left	16ER/L	50	27
200785	C5	Rechts/Right	16ER/L	60	35
200786	C5	Links/Left	16ER/L	60	35
200787	C6	Rechts/Right	16ER/L	65	45
200788	C6	Links/Left	16ER/L	65	45

Ersatzteile Spare Parts						
	Einsatzschraube Insert screw	Unterlegplatte Shim	Wendeplattenschraube Shim screw	Torxschlüssel Torx Key	Sechskantschlüssel Key	Spritzdüse Nozzle
Bestell Nr. Order No.	199984	199988	199991	111651	199993	199979

Drehwerkzeughalter - Innengewinde
Turning tool holders - internal thread



Abbildung zeigt rechte Ausführung
Figure shows right version



Spannschraube
Screw clamp

Externe Kühlmittelzufuhr
External coolant supply

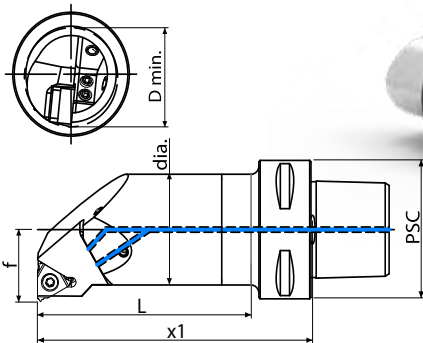

Bestell Nr. Order No.	Größe Size	Ausrichtung Orientation	Einsatz Insert	x1	f	dia. D min	L
200789	C4	Rechts/Right	16IR/L	60	14	20	33 38
200790	C4	Links/Left	16IR/L	60	14	20	33 38
200791	C4	Rechts/Right	16IR/L	70	17	25	33 48
200792	C4	Links/Left	16IR/L	70	17	25	33 48
200793	C4	Rechts/Right	16IR/L	90	22	32	40 69
200794	C4	Links/Left	16IR/L	90	22	32	40 69
200795	C5	Rechts/Right	16IR/L	70	17	25	33 47
200796	C5	Links/Left	16IR/L	70	17	25	33 47
200797	C5	Rechts/Right	16IR/L	90	22	32	33 68
200798	C5	Links/Left	16IR/L	90	22	32	33 68
200799	C5	Rechts/Right	16IR/L	105	27	40	40 84
20800	C5	Links/Left	16IR/L	105	27	40	40 84
20801	C6	Rechts/Right	16IR/L	75	17	25	33 48
20802	C6	Links/Left	16IR/L	75	17	25	33 48
20803	C6	Rechts/Right	16IR/L	90	22	32	33 64
20804	C6	Links/Left	16IR/L	90	22	32	33 64
20805	C6	Rechts/Right	16IR/L	105	17	40	40 80
20806	C6	Links/Left	16IR/L	105	17	40	40 80

Ersatzteile Spare Parts						
	Einsatzschraube Insert screw	Unterlegplatte Shim	Wendeplattenschraube Shim screw	Torxschlüssel Torx Key	Sechskantschlüssel Key	Spritzdüse Nozzle
Bestell Nr. Order No.	199984	199988	199991	111651	199993	199979

mimatic®

Tool Systems

Your Partner For Clever Tooling

- Circular- and Thread Milling Tools
- RPK-Reamers with Polygonal Interface
- Driven Toolholders for CNC Machining Centers
- Driven Toolholders for CNC Turning Machines
- Multi-Spindle Technology
- Modular Quick Change Toolholders mimatic® mi
- Static Toolholders for CNC Turning Machines
- Precision Chucks
- Special Cutting Tools

- Zirkular- und Gewindefräswerkzeuge
- RPK-Reibahlen mit polygonaler Schnittstelle
- Angetriebene Werkzeuge für CNC-Bearbeitungszentren
- Angetriebene Werkzeuge für CNC-Drehmaschinen
- Mehrspindel-Technologie
- Modulare Werkzeugaufnahmen mimatic® mi
- Statische Werkzeugaufnahmen für CNC-Drehmaschinen
- Präzisions-Spannfutter
- Sonder-Zerspannungswerkzeuge



201461 - WM-CAPTO-AUFNAHMEN-DE-EN

mimatic®
Tool Systems



mimatic GmbH
Westendstraße 3
D-87488 Betzigau
Tel. +49 (0) 831 / 574 44-0
info@mimatic.de
www.mimatic.de